

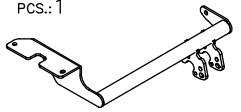

















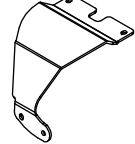

Towbar accessories:

Pos. 1 Main bar PCS.: 1 	Pos. 5 Left fish-plate PCS.: 1 	Pos. 11 Bolt 8,8 B M12x30mm PCS.: 1 	Pos. 17 Plain washer ø37xø13x3mm PCS.: 1 
	Pos. 6 Right fish-plate PCS.: 1 	Pos. 12 Bolt 8,8 B M10x80mm PCS.: 3 	Pos. 18 Plain washer ø13mm PCS.: 2 
Pos. 2 Towball (mounting set) PCS.: 1 	Pos. 7 Distance sleeve ø21,3x2,65mm L=50mm PCS.: 4 	Pos. 13 Bolt DIN7991 M10x90mm PCS.: 1 	Pos. 19 Plain washer ø10,5mm PCS.: 5 
Pos. 3 Socket plate PCS.: 1 	Pos. 8 Distance sleeve ø21,3x2,65mm L=12mm PCS.: 1 	Pos. 14 Bolt 8,8 B M10x30mm PCS.: 1 	Pos. 20 Spring washer ø12,2mm PCS.: 2 
Pos. 4 Right bracket SZTUK: 1 	Pos. 9 Distance washer PCS.: 8 	Pos. 15 Nut 8 B M12 PCS.: 1 	Pos. 21 Spring washer ø10,2mm PCS.: 5 
	Pos. 10 Bolt 8,8 B M12x95mm PCS.: 1 	Pos. 16 Nut 8 B M10 PCS.: 5 	

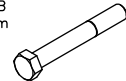

PPUH AUTO-HAK S.J.

Produkcja Zaczepów Kulowych
Henryk & Zbigniew Nejman
76-200 SŁUPSK ul. Słoneczna 16K
tel/fax (059) 8-414-414; 8-414-413
E-mail: office@autohak.com.pl
www. autohak.com.pl

Towing hitch (without electrical set)

Class: **A50-X** Cat. no. **W21A**

Designed for:

Manufacturer: **SUZUKI**

Model: **SWIFT**

produced since 2005 till 08.2010

Technical data:

D-value: 6,4 kN

maximum trailer weight: **1100 kg**

maximum vertical cup load: **50 kg**

Approval number acc. to regulations EKG/ONZ 55.01: **E20-55R-01 1793**

Foreword

This towbar is designed according to rules of safety traffic regulations. The towing hitch is a safety component and can be install only by qualified personnel. Any alteration or conversion of the towing hitch is prohibited and would lead to cancellation of design certification. Remove insulating compound and underseal from vehicle (if present) in the area of the matting surfaces of the towing hitch.

The vehicle manufacturer's specifications regarding trailer load and max. vertical cup load are decisive for driving, and values for the towing hitch cannot be exceeded.

D-value formula:

$$\frac{\text{Max trailer weight [kg]} \times \text{Max vehicle weight [kg]}}{\text{Max trailer weight [kg]} + \text{Max vehicle weight [kg]}} \times \frac{9,81}{1000} = D \text{ [kN]}$$

FITTING INSTRUCTION

Clamp mark in acc. with		Cables joining
ISO	PN	
1	L	Left directional lights
2	+	Rear fog lights
3	31	Ground
4	R	Right directional lights
5	58R	Right side parking lights
6	54	Stoptlights
7	58L	Left side parking lights

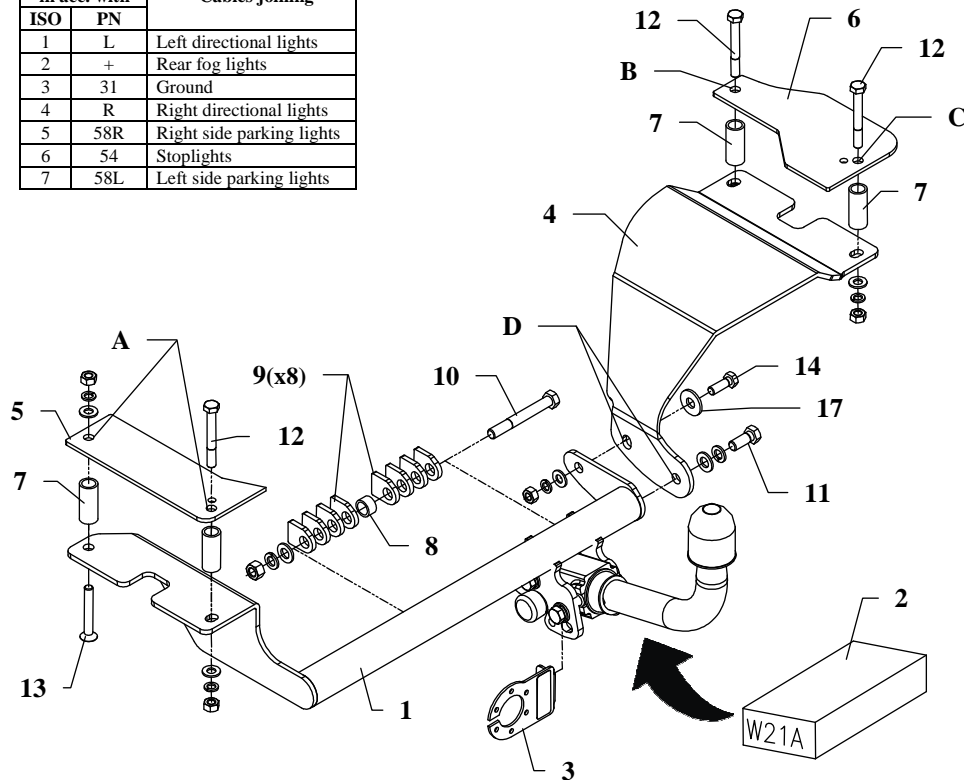

This towbar is designed to assembly in following cars:
SUZUKI SWIFT produced since 2005 till 08.2010, catalogue no. **W21A**
 and is prepared to tow trailers max total weight **1100kg** and max vertical
 load **50kg**.

From manufacturer

Thank you for buying our product. Their reliability has been confirmed in many tests. Reliability of towbar depends also on correct assembly and correct exploitation. For this reasons we kindly ask to read carefully this instruction and apply to hints.

The towbar should be install in points described by a car producer.

The instruction of the assembly

- Disassemble the rear bumper.
- Fold the backseats forward, then fold up the trunk upholstery.
- Loosen the fuel hose support in the lower side of left-side undercarriage extension..
- Find original plugged holes in the trunk on the left side (pos. A) and drill it using bit $\varnothing 10\text{mm}$, then enlarge it to $\varnothing 21\text{mm}$. In holes put distance sleeves (pos. 7).
- Mark floor of the trunk underneath the car in point B and drill using bit $\varnothing 10\text{mm}$.
- Inside the trunk put fish-plate (pos. 6) on hole B, put bolt M10x80mm. Then mark point C, take out fish-plate and drill $\varnothing 10\text{mm}$. Holes pos. B and C enlarge to $\varnothing 21\text{mm}$ and put distance sleeves pos. 7.
- Put bracket (pos. 4) above the exhaust and fix with fish-plate (pos. 6) using bolts M10x80mm (pos. 12) – loosely.
- Main bar of the towbar fix loosely with towing eye – see figure. Distance sleeve (pos. 8) and distance plate (pos. 9) place between ball brackets.
- Fish-plate (pos. 5) put on holes (pos. A) and fix with main bar (pos. 1) using bolt M10x80mm (pos. 12) and countersunk bolt M10x90mm (pos. 13).
- Fix main bar (pos. 1) to bracket (pos. 4) using bolts M12x30mm and M10x30mm (pos. 11 and 14).
- Fix body of the automat and the socket plate (pos. 3) using bolts M12 from accessories. Place tow-ball (pos. 2) according to supplied instruction.
- Reassemble the bumper after cut out his fragment.
- Tighten all bolts according to the torque shown in the table.
- Connect electric wires of 7-poles socket according to the instruction of the car. (Recommend to make at authorized service station)
- Complete paint layer damaged during installation.

Torque settings for nuts and bolts (8,8):

M6 - 11 Nm	M 8 - 25 Nm	M 10 - 50 Nm
M 12 - 87 Nm	M 14 - 138 Nm	M16 - 210 Nm

NOTE

After install the towbar you should get adequate note in registration book (at authorised service station).The car should be equipped with:

- Indicators
- Tow mirrors

After 1000km of exploitation check all bolts and nuts. The ball of towbar must be always kept clear and conserve with a grease.